

Cover: Photos courtesy of Balance Solutions for Today Inc

Electrical Guidelines for Inverter-Based Micro Generation Facilities

1. Scope
2. Overview
 - 2.1 Types of Distributed Generation
 - 2.2 Typical Inverter-Based Micro Generation System
3. Definitions
4. microFIT Projects
 - 4.1 Planning and Installation
 - 4.2 Electrical Inspection Process
5. Net Metering Connection (Load Displacement Projects)
 - 5.1 Planning and Installation
 - 5.2 Electrical Inspection Process
6. Other Sources of Information

1. SCOPE

This guideline is intended to serve a very specific need of inverter based micro generation for the use of one of the following applications:

1. microFIT Program
2. Load displacement

The scope of the guideline deals only with the installation of inverter-based micro generation facilities, 10kW or smaller. For larger generator units, greater than 10kW refer to Spec-005-Process Guideline for the Installation of Parallel Generating Systems (Greater than 10kW). For these larger installations, plans will have to be submitted to the Local Distribution Company and the Electrical Safety Authority for review and approval before any installation work begins.

This guideline is in no way intended to be used as a substitute for the Ontario Electrical Safety Code. Omission of any requirements in the OESC, from this guideline, does not in any way affect the OESC, and these omitted requirements shall not be considered irrelevant. The Ontario Electrical Safety Code is law in Ontario, and as such defines the legal requirements for safe electrical installations and products/equipment in Ontario.

2. OVERVIEW

Today many home, farm and small business owners are considering the installation of alternative forms of electricity generation (distributed generation) and connecting them to run in parallel with the Local Distribution Company (utility) electrical system. This may include the installation of small wind turbines, photovoltaic (solar) systems, micro-hydro turbines or fuel cells. These systems are intended to reduce the amount of power purchased from the local electricity distribution company, or to participate in the FIT Program, and where they are powered from renewable sources such as wind, flowing water or sunlight they also provide environmental benefits.

The Ontario Power Authority has developed the Renewable Energy Feed-In Tariff (FIT) Program for the Province to encourage and promote greater use of renewable energy sources including wind, waterpower, renewable biomass, bio-gas, bio-fuel, landfill gas and solar for electricity generating projects that can be connected to a host facility, a distribution system or the IESO-Controlled Grid, in Ontario. The fundamental objective of the FIT Program, in conjunction with the Green Energy Act (Ontario), is to help facilitate the increased use in the Province of Renewable Generating Facilities of varying sizes, technologies and configurations via a standardized, open and fair process.

Any system that produces even small amounts of electricity can be potentially dangerous, creating the possibility of electrocution and fire hazards. Improperly installed systems will create serious safety hazards to property owners, their friends, family, employees and local electric distribution company workers.

Before installing any type of distributed generation, whether it is stand-alone or connected to the grid, it is important to understand the safety requirements. The safety regulations, the codes and the associated safety technical standards can be confusing and difficult to understand. This guideline is intended to simplify these and provide basic safety advice to home, farm and business owners who are considering the installation of distributed generation systems.

This guideline is based on the requirements of the Electrical Safety Authority's Ontario Electrical Safety Code (OESC) and the Ontario Energy Board's Distribution System Code.

2.1 TYPES OF DISTRIBUTED GENERATION

The Distribution System Code describes four categories of distributed generation.

Generator Classification	Rating
Micro	≤ 10 kW
Small	(a) ≤ 500 kW connected on distribution system voltage < 15 kV (b) ≤ 1 MW connected on distribution system voltage ≥ 15 kV
Mid-Sized	(a) > 500 kW connected on distribution system voltage < 15 kV (b) > 1 MW < 10 MW connected on distribution system voltage > 15 kV
Large	> 10 MW

2.2 TYPICAL INVERTER-BASED MICRO GENERATION SYSTEM

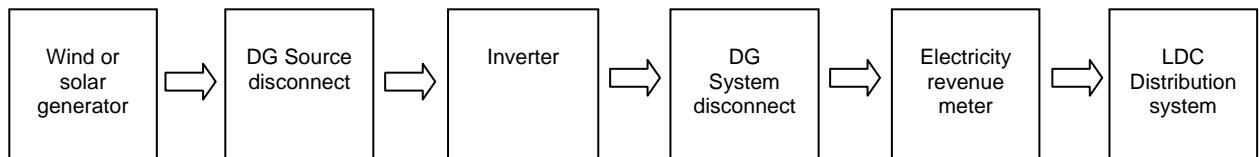

Diagram 1 - Block diagram of basic DG system

3. DEFINITIONS

Approved Electrical Equipment: Equipment that is approved in accordance with the OESC and bears product approval markings for use in Ontario. The presence of approval markings confirms to the user that the equipment is in compliance with the Ontario regulations (Refer to ESA website http://www.esasafe.com/GeneralPublic/epa_002B.php?s=19 for recognized approval marks for products approved for use in Ontario).

Combiner box: A box used in solar installations to combine the multiple photovoltaic arrays to produce one circuit. It often contains generator overcurrent devices.

Disconnecting means: A device, group of devices, or other means whereby the conductors of a circuit can be disconnected from their source of supply. Examples of disconnecting means are a switch or a circuit breaker.

Distributed Generator (DG): Electric generation facilities connected to a Distribution System through a point of common coupling (PCC).

Generator: Equipment that produces electric power. Examples of inverter-based micro generators are wind turbine and photovoltaic array, both of which produce Direct Current (DC) power.

DG Source Disconnect: Disconnecting means to disconnect the distributed generation source from the equipment that it supplies.

DG System Disconnect (Utility Disconnect): Disconnecting means to disconnect the distributed

generator from the utility distribution system. This disconnect ensures the safety of electrical utility workers by allowing them to disconnect the generator from the utility system in case they have to service or repair the electrical supply to your home, farm or business. Also referred to as “utility disconnect”.

Distribution Panel: The distribution panel contains overcurrent devices and distributes electricity to the various electrical circuits and equipment in your home, farm or business.

Distribution System Code (DSC): Sets out the minimum conditions that an electricity distributor must meet in carrying out its obligations, the DSC is established and approved by the Ontario Energy Board (OEB). All licensed electricity distributors in Ontario must comply with the provisions of the DSC as a condition of their license.

Electricity Revenue Meter: The Local Distribution Company supplies and installs the electricity revenue meter that measures consumption (Load Meter) or generation (Generation Meter) of electrical energy by the customer.

Inverter: Means a device that converts DC electricity generated from into AC electricity. Electrical equipment, appliances, tools, machines and lights connected to the wiring in your home, farm or business use alternating current (AC) power.

Stand-Alone Inverter: An inverter that operates only in stand-alone mode and thus contains no facility to synchronise its output energy to a Utility Distribution.

Utility-interconnected inverter: An inverter that is able to operate in grid parallel mode with the utility distribution facility. Thus contains provision for anti-islanding and for synchronizing its output voltage, phase and frequency to the utility distribution. Also known as grid connected, or grid tie inverter. There are two types of utility-interconnected inverter; a grid dependant and a grid Interactive.

Grid Dependent Inverter: An inverter that is able to operate in parallel to the distribution system and in order to operate there must be power available from the electric utility's electricity grid. Loss of power from the grid will initiate a shutdown of the inverter to prevent islanding. Distributed generation systems using a grid dependent inverter will not provide back-up power during a utility power outage.

Grid-interactive inverter: An inverter that is able to operate in both stand-alone and grid-parallel modes according to the availability of the distribution system. It can be considered as an uninterruptible power supply that is also able to operate in grid-parallel mode. This type of inverter initiates grid-parallel operation.

Island: A condition in which a portion of the utility distribution system is energized by a utility-interconnected inverter while that portion of the utility distribution system is electrically separated from the rest of the utility distribution system.

Anti-islanding: The micro-distributed generator system shall cease to energize the utility distribution system after the formation of an unintentional island (i.e. meet the anti-islanding requirements of CSA C22.2 No. 107.1).

Local Distribution Company (LDC): The distribution of electricity to end use customers is carried out by Ontario's local electrical utilities or LDCs. These utilities are responsible for maintaining their community's network of distribution wires. Also referred to as “supply authority”.

Micro-embedded generation facility: Means a generation facility connected on the customer side of the electricity meter that produces 10kW of electricity or less.

microFIT Program: Is the FIT program developed for renewable energy projects that are 10kW or less in capacity.

Feed-in Tariff (FIT) Program: Is defined as the renewable Energy Feed-In Tariff Program established by the OPA pursuant to the FIT Rules and any prior or subsequent version of the FIT Rules.

microFIT Rules: The Rules governing the microFIT program as may be amended from time to time and is posted on the OPA website <http://microfit.powerauthority.on.ca/pdf/microFIT-Rules.pdf>

Meter Connection: The meter connection configuration determines the application type for the project.

Series meter connection: The installation includes two revenue meters, connected in series. The Load meter and the Generation meter. The generation meter and the generator are connected beyond the load meter (**Indirectly Connected microFIT project**). Refer to Diagram A.

Parallel meter connection: The installation includes two revenue meters, connected in parallel; the Load meter and the Generation meter. The two meters could have one connection point (**Indirectly Connected microFIT project**) or two separate connection points (**Directly Connected microFIT project**). Refer to Diagram B.

Net metering connection: The installation includes one revenue load meter. The generator is connected beyond the load meter, the generated power is used for load displacement; the project is a **Micro-embedded Load Displacement project**. Refer to Diagram C.

Ontario Electrical Safety Code (OESC): Provides the standards for the safe installation of all temporary and permanent electrical wiring and equipment. The OESC applies to all homes, businesses, farms and industry in Ontario. The Ontario Electrical Safety Code is law in Ontario, and as such defines the legal requirements for safe electrical installations and products/equipment in Ontario

Overcurrent Device: A fuse or circuit breaker. An approved fuse or circuit breaker is required to protect people and the electrical system from a short circuit or overload failures. This is an important safety device.

Service box: Is an approved assembly consisting of an enclosure that can be locked or sealed, containing either fuses and a switch, or a circuit breaker, and of such design that it is possible to operate either the switch or circuit breaker to the open position by manual means when the box is closed.

4. microFIT PROJECTS

4.1 PLANNING AND INSTALLATION

Before you begin any installation work or make any commitments to purchase equipment or have equipment installed, it is very important that you do your homework first.

A. Information to be gathered and reviewed:

- 1. Review the Ontario Power Authority (OPA) website**
Refer to the microFIT Rules, for project eligibility, application, contract terms, etc. specific to the microFIT program, as required and administered by the OPA
<http://microfit.powerauthority.on.ca/>
- 2. Review the Ontario Energy Board's Distribution System Code (Appendix F)**
This document provides an outline for the micro-generation connection process.
http://www.oeb.gov.on.ca/documents/cases/EB-2005-0447/appendixf_201206.pdf
- 3. Review these Electrical Safety Authority Guidelines**
Be sure to review and understand the Electrical Safety Authority guidelines, including the requirements for electrical inspection and approval. An "Application for Inspection" is required.
- 4. Some questions to consider are:**
 - Is a service upgrade required to accommodate the installation of an alternative generator?
 - Are there any other special technical requirements?
 - What is the connection configuration? Is it a series connection, or is it a parallel connection? Discuss with your LDC
 - Will the revenue meter need replacing?
 - What are the charges for this connection?
- 5. Check for any local bylaw or permit requirements.**
In addition to ensuring that you understand the electrical safety requirements you should also check with you local municipality, township or county about any bylaw or permit requirements that might apply depending on the type of installation.

B. Proceeding with the Installation:

- 1. Apply through the Ontario Power Authority (OPA) website**
- 2. Submit a connection request form to your LDC**

Refer to your LDC website or contact them for information regarding their connection process for renewable energy and microFIT projects.

- 3. Select Your Electrical Contractor**

Prior to hiring an Electrical Contractor, confirm that they are licensed by the Electrical Contractor Registration Agency of the Electrical Safety Authority (ECRA/ESA)

It is also recommended that you ensure that:

- They can provide references

- They are prepared to take out the necessary “Application for Inspection”. If the person you are considering for the installation tells you that an electrical inspection is not required or suggests that you apply for the inspection on his or her behalf find someone else to do the work.
- They will provide a written estimate of the cost of the work.
- You ask about the amount of experience the electrical contractor has installing alternative generation systems.
- If the electrical contractor is providing the electrical equipment as part of the installation ensure that they are providing and installing approved equipment.
- They will provide you with a copy of the “Certificate of Inspection”. The Local Distribution Company will require a copy of the “Certificate of Inspection” before they will finalize the connection agreement with you. You may wish to hold back final payment until you get this certificate.

4. File a Completed Application for Inspection with the Electrical Safety Authority

Before beginning the electrical work (or within 48 hours), your electrical contractor must file an Application for Inspection with the Electrical Safety Authority and pay the appropriate fees. For the installation of micro-generation systems the submission and approval of plans is not required. If you are the homeowner and you are doing the work (not recommended) you are responsible for filing the application for inspection.

1-877-ESA-SAFE (1-877-372-7233) || www.esasafe.com

An Electrical Inspector will inspect the installation to determine if it meets the requirements of the OESC, as outlined below.

If the installation meets the safety requirements identified in the OESC, then a “Connection Authorization” will be issued to the LDC and a “Certificate of Inspection” will be provided to the electrical contractor. These documents provide assurance that the installation was inspected by ESA, was found in compliance with the requirements of the OESC, and may be connected and used.

5. Finalize the connection agreement with the LDC and the microFIT contract with the OPA

4.2 ELECTRICAL INSPECTION PROCESS

Before the generator can be connected to the electrical system it must be inspected and approved by the Electrical Safety Authority. The OESC requires an Application for Inspection to be submitted by the contractor doing the electrical installation. The inspection provides assurance that the installation meets the safety requirements of the OESC. The electrical inspection process does not include the inspection of the structural integrity of the roof, the windmill installation or other non-electrical infrastructure for the installed generator equipment.

If the microFIT project is converting from an existing installation, e.g. a Net-metering/Load displacement installation, the entire distributed generator system installation shall be inspected by the ESA. Notwithstanding product approval requirements in Ontario, existing installations including equipment that are approved to UL standards will be accepted.

In addition to the standard inspection process, to verify that the electrical work meets the OESC, the ESA will be reporting the following to the LDC/OPA:

1. The type of the renewable energy of the project.
2. The project capacity.
3. Verification if batteries are installed upstream of the generator meter.

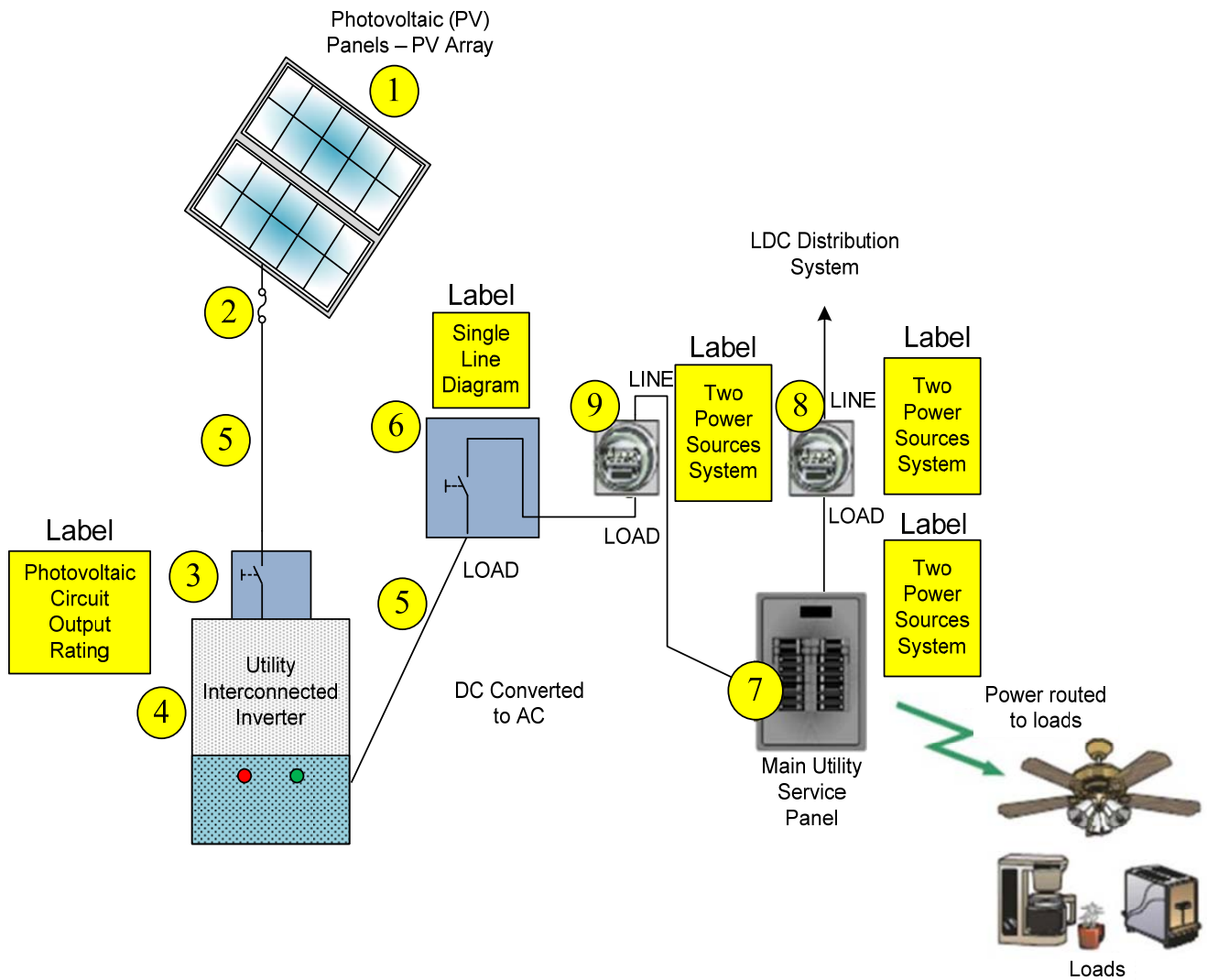

Diagram A: Series Meter Connection – microFIT Project

[Note: The two revenue meters have one connection point to the LDC Distribution System (Indirectly Connected project)]

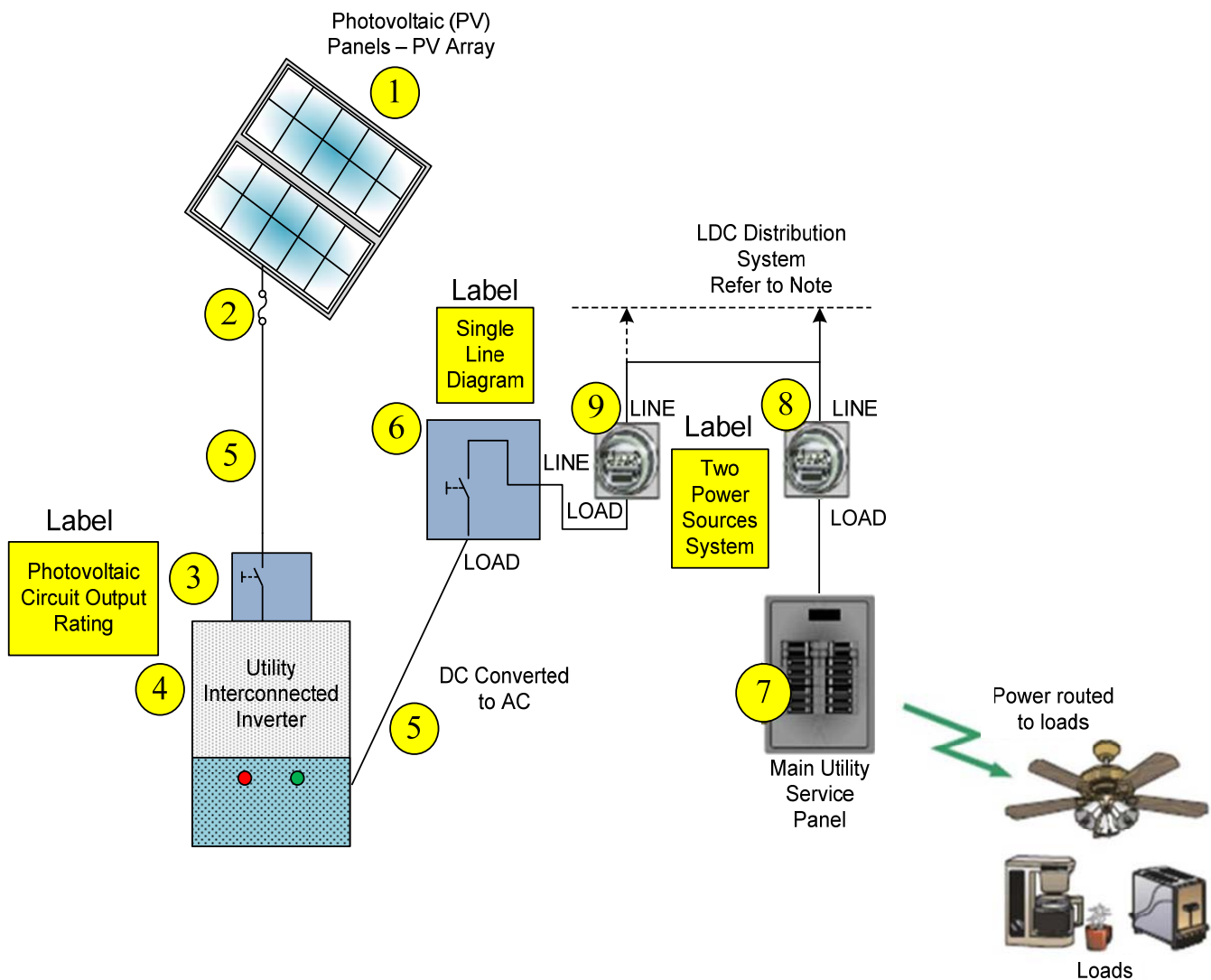

Diagram B: Parallel Meter Connection – microFIT Project

[Note: The two revenue meters may have one connection point (Indirectly Connected project) or two separate connection points (Directly Connected project) to the LDC Distribution System; consult with the LDC on the connection of the meters]

All electrical devices and equipment shall be approved and bear accepted product approval markings for use in Ontario.

With reference to the above diagrams, the following is required according to the OESC:

1 Generator type and characteristics

The generator could be wind powered, photovoltaic, micro-hydro, etc. The Inspector will check the nameplate and note the generator electrical characteristics. Manufacturer specifications shall be made available to the inspector.

For Solar installations, flexible cords for extra-hard usage shall be permitted to interconnect modules within an array. If the combiner box is installed within the array, flexible cord shall be permitted to connect the array to the combiner box.

2 Overcurrent Device(s)

Where required by the OESC for protection of downstream conductors and equipment from overcurrent (short circuit or overload). The rating and type shall be compliant with the OESC based on the generator nameplate ratings and the downstream conductors and equipment.

For a Solar installation, the overcurrent devices may be located in the combiner box. The combiner box shall be permitted to be located on the roof.

3 Disconnecting Means – Generator or Distributed Generation (DG) Source

The disconnecting means shall be sized to safely disconnect the output of the generator unit. The OESC provides information on the sizing requirements and a licensed electrical contractor will be familiar with these. The disconnecting means shall have a label marked “DG SOURCE DISCONNECT”.

For solar installations, a permanent marking shall be provided at an accessible location at the disconnecting means for the photovoltaic output circuit specifying; rated operating current and voltage; rated open-circuit voltage; and rated short-circuit current.

Some Inverters units might have the disconnecting means built into the inverter unit. In that case, the label “DG SOURCE DISCONNECT” will be on the inverter unit. If this is the case a separate disconnecting means is not required.

If the inverter is an integral part of the generator, and the combined unit is approved, there is no DG SOURCE DISCONNECT required.

4 Utility Interconnected Inverter

An approved Utility Interconnected Inverter is required. The inverter shall bear a certification mark that indicates that the inverter meets the requirements of the Canadian Standards Association Standard CSA C22.2 #107.1. Field Evaluation shall not be accepted for “Utility Interconnected Inverter”. The Inspector will also check the nameplate and note the Inverter electrical characteristics.

The inverter shall bear a label stating “UTILITY-INTERCONNECTED” indicating it meets the standard for utility interconnected inverters.

5 Wiring Methods

Wiring shall be installed in accordance with requirements set out in Section 12 of the OESC.

All exposed installations including cables, conduits, connector, attachment plugs, etc will be approved for outdoor installations and marked accordingly.

For Solar installations, refer also to Section 50 for additional requirements. Permanent wiring methods identified in Section 12 shall be used to interconnect the inverter to the array.

6 Disconnecting Means — Distributed Generation (DG) System (Utility disconnect)

The inspector will verify that a disconnecting means (intended to prevent back feed into the utility system) is installed. The disconnecting means shall be located adjacent to the utility meter(s) and have contact operation verifiable by direct visible means if required by the LDC. The disconnecting means shall be properly sized to disconnect the electrical output from the inverter, have provision for being locked in the open position and it will simultaneously disconnect all ungrounded conductors of the distributed generator from the distribution supply system.

NOTE: Verify if your LDC requires contact operation to be verified by direct visible means.

The disconnecting means shall have a label marked “DG SYSTEM DISCONNECT – WARNING – TWO POWER SOURCES”.

A single line diagram shall be posted at the disconnecting means. This single line diagram must be plainly and permanently marked, shows the switching arrangements, the location of the disconnecting means, the location and type of generator. The single line diagram should identify related components of the interconnected system, including switching arrangements, interlocks, isolation points, and their relative locations.

For Parallel Meter Connection – Diagram B:

The disconnecting means shall be an **approved service box** and grounded as per Section 10 of OESC requirements. This disconnect will serve as the service box and a Utility disconnect.

7 Distribution Panel

For Series Meter Connection – Diagram A:

The circuit breaker in the distribution panel that connects to the distributed generation system shall not have any Line/Load markings. The Inspector will check to see that the circuit breaker is of adequate ampere and voltage rating and has an interrupt rating greater than the available fault current from the distribution system. The circuit breaker shall be clearly labelled to indicate its purpose, and shall not feed any other loads.

The main circuit breaker or disconnecting means for the distribution panel shall be labelled “WARNING – TWO POWER SOURCES”. A warning label shall also be posted at any distribution panel, load break switch, etc, were there exists the possibility of feedback.

For Parallel Meter Connection – Diagram B:

There is no connection to the generator system from the customer’s distribution panel for this type of configuration.

8 Electricity Revenue Meter – Customer Load Meter

The electricity meter is the responsibility of the electrical utility.

For Series Meter Connection – Diagram A:

A label marked “WARNING – TWO POWER SOURCES” shall be affixed in a location adjacent to the electricity revenue meters. This label provides a warning to utility workers that your generator is capable

of providing electricity into the utility system. It alerts them that they should disconnect the generator from the electrical supply system before beginning any work on the electrical system supplying your home, farm or business.

9 Electricity Revenue Meter – Generation Meter

The electricity meter is the responsibility of the electrical utility. An approved meter mounting base shall be installed to meet the LDC requirements. Meter's line side shall be connected to the LDC side and the load side shall be connected to the Generator Source wiring. The line side of the meter base shall be connected with a 3-wire 120/240V.

A label marked "WARNING – TWO POWER SOURCES" shall be affixed in a location adjacent to the electricity revenue meters. This label provides a warning to utility workers that your generator is capable of providing electricity into the utility system. It alerts them that they should disconnect the generator from the electrical supply system before beginning any work on the electrical system supplying your home, farm or business.

5. NET METERING CONNECTION (LOAD DISPLACEMENT PROJECT)

5.1 PLANNING AN INSTALLATION

For Load displacement projects, the process is simpler and this project does not need to apply through OPA. The Ontario Energy Board's Distribution System Code (Appendix F) provides an outline for the micro-generation connection process, as follows.

Net Metering is an agreement between the LDC and a customer who generates electricity from renewable resources. The customer produces and consumes electricity, and may send surplus energy to the grid.

GENERATION CONNECTIONS MICRO ≤ 10 kW

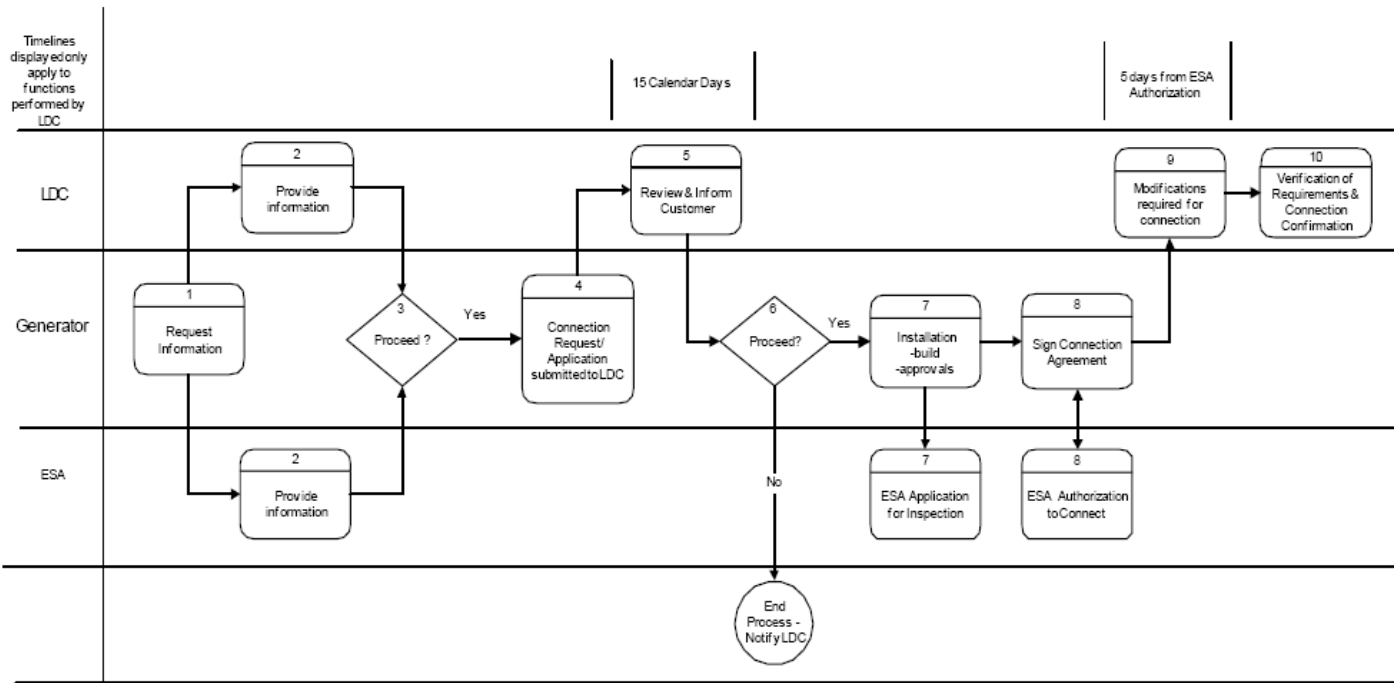

(Source: OEB's Process and Technical Requirements for Connecting Embedded Generation Facilities)

5.2 ELECTRICAL INSPECTION PROCESS

Before the generator can be connected to the electrical system it must be inspected and approved by the Electrical Safety Authority. The OESC requires an Application for Inspection to be submitted by the contractor doing the electrical installation. The inspection provides assurance that the installation meets the safety requirements of the OESC.

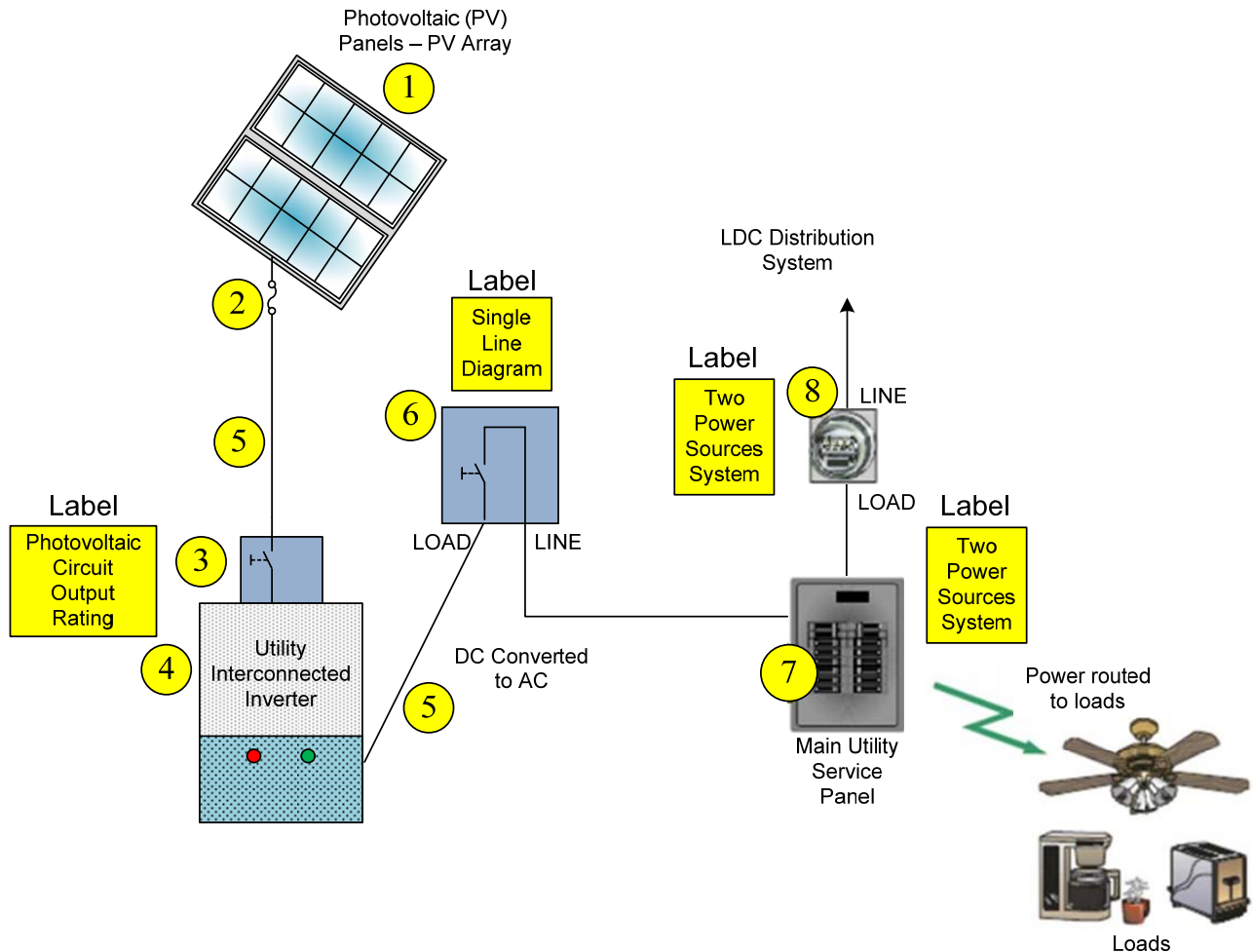

Diagram C: Net metering connection - Micro-embedded Load Displacement project

With reference to the above diagram, the Inspector will look for the requirements similar to a series connected project as outlined above, in Diagram A, when inspecting the generation installation. The only difference is that there is only one meter in the installation which is the **Load Meter**.

6. OTHER SOURCES OF INFORMATION





















- Ontario Electrical Safety Code
- CSA C22.2 #107.1 General Use Power Supplies
- ULC/ORD-C1703-01 Flat Plate Photovoltaic Modules and Panels
- The Renewable Energy Handbook for Homeowners by William H. Kemp
- \$mart Power; an urban guide to renewable energy and efficiency The Renewable Energy Handbook for Homeowners by William H. Kemp
- Distribution System Code published by OEB
- Standby Generators and Emergency Power Information By Ministry of Agriculture and Food
 - Generator Handbook
 - Generator fact sheets
 - <http://www.omafra.gov.on.ca/english/engineer/energy.html>
- Electricity Generation Using Small Wind Turbines at Your Home or Farm, by S. Clarke of the Ministry of Agriculture
- CAN/CSA-C22.2 No. 257-06 Interconnecting Inverter-Based Micro-Distributed Resources to Distribution Systems

To file for an Application for Inspection call: **1-877-ESA-SAFE (372-7233)**

www.esasafe.com

Appendix A

Certification marks acceptable under the OESC of the Province of Ontario are:

Canadian Standards Association (CSA)			
Curtis Strauss		Entela	
FM Approvals			
Intertek Testing Services			
Labtest Certification (LC)			
Met Laboratories (MET)		Nemko	
NSF International		OMNI Environmental Services Inc	
Quality Auditing Institute		QPS	
TUV America		TUV Rheinland	
Underwriters' Laboratories of Canada (ULC)			
Underwriters' Laboratories Inc.	